

**OWNER'S MANUAL**

**SALUSPA®**

**Bestway®**



# CONTENTS

---

<b>IMPORTANT SAFETY INSTRUCTIONS</b>	<b>pg 004</b>
<b>PRE-SETUP CHECK LIST</b>	<b>pg 009</b>
<b>INSTALLATION</b>	<b>pg 010</b>
<b>SET-UP INSTRUCTION IN WINTER</b>	<b>pg 010</b>
<b>USING THE SPA</b>	<b>pg 013</b>
<b>MAINTENANCE</b>	<b>pg 016</b>
<b>DISASSEMBLY AND STORAGE</b>	<b>pg 018</b>
<b>TROUBLESHOOTING</b>	<b>pg 020</b>
<b>ERROR CODES</b>	<b>pg 021</b>



**VISIT BESTWAY YOUTUBE CHANNEL**

FOR INSTRUCTION VIDEOS  
PLEASE VISIT:

**[BESTWAYCORP.COM/SUPPORT](http://BESTWAYCORP.COM/SUPPORT)**

# IMPORTANT SAFETY INSTRUCTIONS

## WARNING

### IMPORTANT SAFETY INSTRUCTIONS

When using this electrical equipment, basic safety precautions should always be followed, including the following:

### READ AND FOLLOW ALL INSTRUCTIONS.

**WARNING** - To reduce the risk of injury, do not permit children to use this product unless they are closely supervised at all times.

A wire connector is provided on this unit to connect a minimum 8 AWG (8.37 mm<sup>2</sup>) solid copper conductor between this unit and any metal equipment, metal enclosures of electrical equipment, metal water pipe, or conduit within 5 feet (1.5 m) of the unit.

**DANGER** - Risk of injury.

- a) Replace damaged cord immediately.
- b) Do not bury cord.
- c) Connect to a grounded, grounding type receptacle only.

**WARNING** - This product is provided with a ground-fault circuit-interrupter integrated with the power plug at the end of the cord. The GFCI must be tested before each use. With the product operating, push the test button on the GFCI and the product should not operate. Push the reset button on the GFCI and the product should now operate normally. When the product fails to operate in this manner, there is a ground current flowing indicating the possibility of an electrical shock. Disconnect the power until the fault has been identified and corrected.

**DANGER** - Risk of Accidental Drowning. Extreme caution must be exercised to prevent unauthorized access by children. To avoid accidents, ensure that children cannot use this spa unless they are supervised at all times.

**DANGER** - Risk of Injury. The suction fittings in this spa are sized to match the specific water flow created by the pump. Should the need arise to replace the suction fittings or the pump, be sure that the flow rates are compatible. Never operate spa if the suction fittings are broken or missing. Never replace a suction fitting with one rated less than the flow rate marked on the original suction fitting.

**DANGER** - Risk of Electric Shock. Install at least 5 feet (1.5 m) from all metal surfaces. As an alternative, a spa may be installed within 5 feet of metal surfaces if each metal surface is permanently connected by a minimum 8 AWG (8.37 mm<sup>2</sup>) solid copper conductor to the wire connector on the terminal box that is provided for this purpose.

**DANGER** - Risk of Electric Shock. Do not permit any electric appliance, such as a light, telephone, radio, or television, within 5 feet (1.5 m) of a spa.

**WARNING** - To reduce the risk of injury:

- a) The water in a spa should never exceed 104°F (40°C). Water temperatures between 100°F (38°C) and 104°F (40°C) are considered safe for a healthy adult. Lower water temperatures are recommended for young children and when spa use exceeds 10 minutes.
- b) Since excessive water temperatures have a high potential for causing fetal damage during the early months of pregnancy, pregnant or possibly pregnant women should limit spa water temperatures to 100°F (38°C).
- c) Before entering a spa, the user should measure the water temperature with an

accurate thermometer since the tolerance of water temperature-regulating devices varies.

- d) The use of alcohol, drugs, or medication before or during spa use may lead to unconsciousness with the possibility of drowning.
- e) Obese persons and persons with a history of heart disease, low or high blood pressure, circulatory system problems, or diabetes should consult a physician before using a spa.
- f) Persons using medication should consult a physician before using a spa since some medication may induce drowsiness while other medication may affect heart rate, blood pressure, and circulation.

**WARNING:** TO AVOID ELECTRIC SHOCK, DO NOT USE THE SPA WHEN IT IS RAINING.

**WARNING:** Water attracts children; Always attach a spa cover after each use.

**WARNING:** TO REDUCE THE RISK OF INJURY: Never add water that is higher than 104°F (40°C) into the Spa.

**CONSULT YOUR PHYSICIAN FOR RECOMMENDATIONS.**

**CAUTION:**

We strongly recommend not to unfold and inflate the spa if the ambient temperature is below 59°F(15°C). We suggest inflating the spa indoors, and then continuing set up outdoors. If the outdoor temperature is lower than 42.8°F(6°C), the spa heater must always be on. In this mode, the Freeze Shield™ system can keep the internal temperature between 42.8°F(6°C) and 50°F(10°C) to prevent damage, such as water freezing in the pipes or the circulation system.

**IMPORTANT:** If the Freeze Shield™ system isn't working, alarms will pop up on the spa. Be sure to check the status of your spa if the outdoor temperature is below 42.8°F(6°C). In case of a long-term absence from home when there is a risk of temperatures falling below 42.8°F(6°C), we strongly suggest disassembling the spa and storing it following the storage procedure.

**CAUTION:** Do not use the spa alone.

**CAUTION:** Always enter and exit the spa slowly and cautiously. Wet surfaces are slippery.

**CAUTION:** To avoid damage to the pump, the spa must never be operated unless the spa is filled with water.

**CAUTION:** Immediately leave spa if the user feels uncomfortable or sleepy.

**NOTE:** Please examine equipment before use. Notify Bestway® at the customer service address listed on this manual for any damaged or missing parts at the time of purchase. Verify that the equipment components represent the model that you had intended to purchase.

This device complies with part 15 of the FCC Rules. Operation is subject to the following two conditions: (1) This device may not cause harmful interference, and (2) this device must accept any interference received, including interference that may cause undesired operation.

Any changes or modifications to this unit not expressly approved by the party responsible for compliance could void the user's authority to operate the equipment.

**NOTE:** This equipment has been tested and found to comply with the limits for a Class B digital device, pursuant to part 15 of the FCC Rules. These limits are designed to provide reasonable protection against harmful interference in a

residential installation. This equipment generates, uses and can radiate radio frequency energy and, if not installed and used in accordance with the instructions, may cause harmful interference to radio communications. However, there is no guarantee that interference will not occur in a particular installation. If this equipment does cause harmful interference to radio or television reception, which can be determined by turning the equipment off and on, the user is encouraged to try to correct the interference by one or more of the following measures:

- Reorient or relocate the receiving antenna.
- Increase the separation between the equipment and receiver.
- Connect the equipment into an outlet on a circuit different from that to which the receiver is connected.
- Consult the dealer or an experienced radio/TV technician for help.

**ASSEMBLY: THE PROVIDED WARNING LABEL**



# WARNING

## REDUCE THE RISK OF ELECTROCUTION

1. NEVER PLACE AN ELECTRIC APPLIANCE WITHIN 5 FEET OF SPA.

## REDUCE THE RISK OF CHILD DROWNING

1. SUPERVISE CHILDREN AT ALL TIMES.
2. ATTACH SPA COVER AFTER EACH USE.

## REDUCE THE RISK OF OVERHEATING

1. CHECK WITH A DOCTOR BEFORE USE IF PREGNANT, DIABETIC, IN POOR HEALTH, OR UNDER MEDICAL CARE.
2. EXIT IMMEDIATELY IF UNCOMFORTABLE, DIZZY, OR SLEEPY. SPA HEAT CAN CAUSE HYPERTHERMIA AND UNCONSCIOUSNESS.
3. SPA HEAT IN CONJUNCTION WITH ALCOHOL, DRUGS, OR MEDICATION CAN CAUSE UNCONSCIOUSNESS.

**WHEN PREGNANT**, SOAKING IN HOT WATER FOR LONG PERIODS CAN HARM YOUR FETUS. MEASURE WATER TEMPERATURE BEFORE ENTERING.

1. DO NOT ENTER SPA IF WATER IS HOTTER THAN 100°F(38°C)
2. DO NOT STAY IN SPA FOR LONGER THAN 10 MINUTES.

**NOTE:** The warning label must be posted near your spa in a readable position during using your spa.

1. Take out the warning label from the accessory kit.
2. Carefully peel the warning label.
3. Affix the warning label.

To order the warning label, please contact your local Bestway After Sales Service.

# SPA SUCTION FITTING INSTRUCTIONS

When installing and using this equipment, basic safety precautions shall always be followed, including the following:

## IMPORTANT SAFETY INSTRUCTIONS READ, FOLLOW, AND UNDERSTAND ALL INSTRUCTIONS AND WARNINGS.

- Any modification that increases the flow rate of the circulation system shall require re-evaluation of the cover/grate and sump to ensure that the flow rating of the Suction Outlet Fitting Assembly (SOFA) is not exceeded.
  - Missing, broken, or cracked cover/grates, sumps, mud-frames, or any other SOFA component shall be replaced before bathers are allowed to use the pool.
  - Loose cover/grates shall be reattached before bathers are allowed to use the pool.
1. Replace suction fittings every 3 years.
  2. The use of adhesives or other attachment methods that prevent access to suction piping or SOFA components requiring periodic servicing is prohibited.
  3. Refer to the following diagram for each SOFA component part instructions:

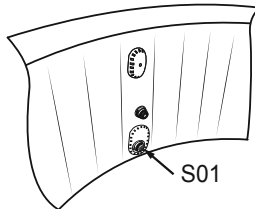

4. Any field modification made to a SOFA not authorized by the manufacturer's installation instructions shall void the SOFA certification.
  - No modification shall be made to a SOFA structure or flow path unless the new configuration has been certified as new SOFA.
  - Cover/grates and all other SOFA components shall be replaced at or before the end of their service life and that service life begins the month and year in which a SOFA component is installed with or without water.
5. Winterizing instructions. Dry the suction fittings completely, and store the product in a dry room at a storage temperature of 59°F~104°F(15°C~40°C).
  - Cover/grate, including fasteners, shall be observed for damage or tampering each operational day.
  - Missing, broken, or cracked cover/grates shall be replaced before bathers are allowed to use the pool.
  - Loose cover/grates and associated components shall be reattached before bathers are allowed to use the pool.
  - SOFA components and fastener receptacles shall be clean and free of debris or obstructions during installation of cover/grate and fasteners.
  - Remember to hand-check cover/grate for snugness to the sump/ frame after installation.
6. Before using the product, please check the integrity of the head of the suction fitting. If the product is broken, please do not use it.
7. All SOFAs shall be installed in accordance with the manufacturer's installation instructions.
  - No modification shall be made to a SOFA structure or flow path unless the new configuration has been certified to the original SOFA.

- These SOFA-configuration specific flow ratings NOT be exceeded at any time the pool is open to bathers.
- Cover/grates, when installed, shall not protrude more than 2 in. (51 mm) from the finished surface of the pool in which the SOFA is installed.

8. 

<p>Installation Information label (Copy)  Manufacturers name: Bestway (Nantong) Recreation Corp.  Cover part number: S01  Life expectancy: 3 Years  Cover flow rating: 20 GPM  Configuration and installed orientation: Wall  Location: Spa Pool liner  Date of installation: _____  Installer need to fill in the balance of information and give it to the pool owner, to be kept with other important pool related documents.</p>
--

Please research and download General Certificate of Conformity through [www.bestwaycorp.com](http://www.bestwaycorp.com)

## SAVE THESE INSTRUCTIONS SELECTED LOCATION

**IMPORTANT:** Due to the combined weight of the SaluSpa, water, and users, it is extremely important that the surface where the SaluSpa is installed is smooth, flat, level and capable of supporting the weight for the entire time the SaluSpa is installed (not on the carpet or other similar material). If the SaluSpa is placed on a surface which does not meet these requirements, any damage caused by improper support is not covered under the manufacturer’s warranty. It is the responsibility of the SaluSpa owner to assure the integrity of the surface at all times.

**1. Indoor Installation:**

**Be aware of special requirements if you install the spa indoors.**

- Humidity is a natural side effect with SaluSpa installation. First determine the effects of moisture on exposed wood, paper, etc. in the proposed location. To minimize these effects, it is best to provide plenty of ventilation to the selected area. An architect can help determine if more ventilation is needed.

**2. Outdoor Installation:**

- During filling, draining or when in use, water may spill out of the spa. Therefore the SaluSpa should be installed near a floor drain.
- Do not leave the spa surface exposed to direct sunlight for long periods of time.

## GFCI WARNING

**IMPORTANT:** RISK OF ELECTRIC SHOCK. THE GFCI MUST BE TESTED BEFORE TURNING ON THE PUMP EACH TIME.

**WARNING:** The GFCI plug must be tested before each use to avoid risk of electric shock.

**WARNING:** Before inserting plug into a power outlet, make sure the current rate of the power outlet is suitable for the pump.

**WARNING:** Do not use the pump if this test fails. For assistance, please visit the support section on our website, [www.bestwaycorp.com](http://www.bestwaycorp.com).

**WARNING:** Using an extension lead or multi plug adaptor with the spa heater can cause the plug to overheat, causing damage to the equipment and surrounding items. The spa is a class I electrical appliance and must be connected directly to a grounded socket. It is recommended to only use a socket which is resistant to humidity and capable of high power loading. Regularly check the plug and socket for signs of damage before using the spa – do not use the spa if the plug or socket is damaged. If you are unsure about the quality of the electrical supply, please consult a qualified electrician before use.



# PRE-SETUP CHECK LIST

## PARTS CHECKS

Please examine equipment before use. Notify Bestway® customer service of any damaged or missing parts at the time of purchase. Verify that the equipment components represent the model that you had intended to purchase. For reference please use the diagrams below.

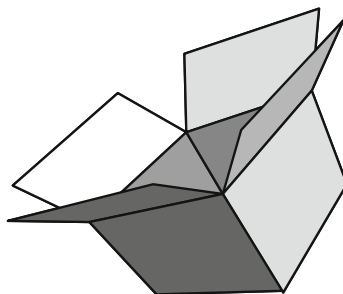

### MOSSY OAK AIRJET S100105

— 71" x 26" / 1.80 m x 66 cm



2-3°F/h  
1-1.5°C/h



320 gal/h  
1,211 L/h



0.034-0.055Bar  
0.5-0.8PSI

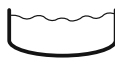

177 gal  
669 L



1,534 Lb  
696 kg

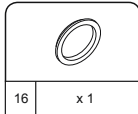
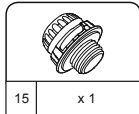
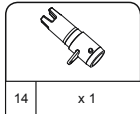
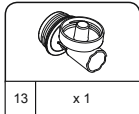
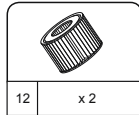
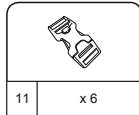
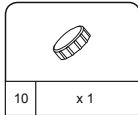
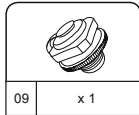
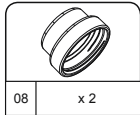
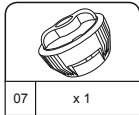
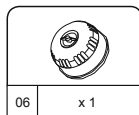
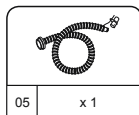
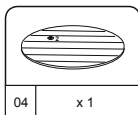
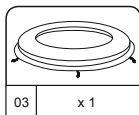
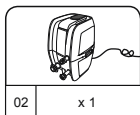
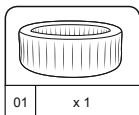

# INSTALLATION



## SET-UP INSTRUCTION IN WINTER

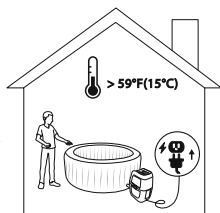
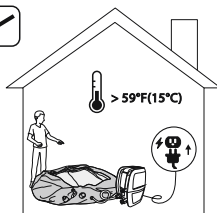
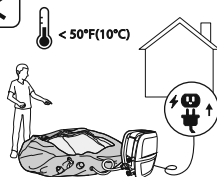

It is important to follow these suggestions if you are setting up the spa during the winter period.

This will prevent damage to the PVC material and extend the life of your product drastically.

- If the ambient temperature is below 50°F (10°C), we suggest keeping the package indoor where the temperature is above 59°F (15°C) for at least 2h before inflation. This will make the spa liner more flexible and easier to set up.
- Open the package in the same room where the temperature is above 59°F (15°C), and inflate the spa using the spa heater.
- Position the spa liner outdoor in the desired position, connect the spa heater and fill with water.

**Important:** The water temperature used to fill the spa must be above 42.8°F (6°C), otherwise when you begin to operate with the spa heater, the E03 alarm will appear.

**Important:** If the Freeze Shield™ system isn't working, alarms will pop up on the spa. Be sure to check the status of your spa if the outdoor temperature is below 42.8°F (6°C). In case of a long-term absence from home when there is a risk of temperatures falling below 42.8°F (6°C), we strongly suggest disassembling the spa and storing it following the storage procedure. When you assemble the spa, the automatic warm function will turn on. In this condition, the spa can be used when the temperature is lower than 42.8°F (6°C).

1

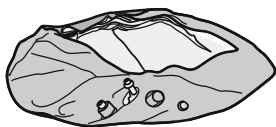

2

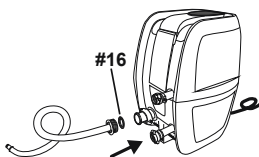

3

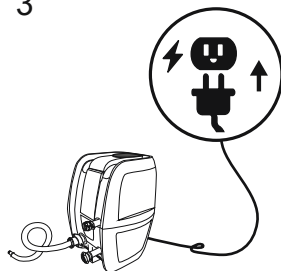

4

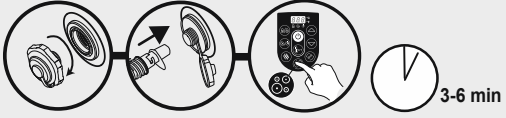
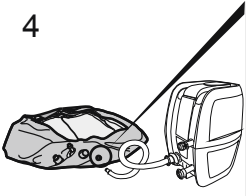

5

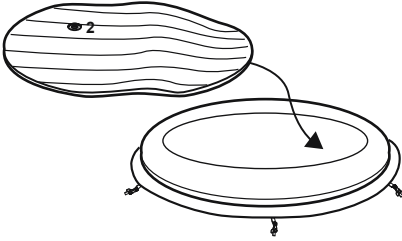

6

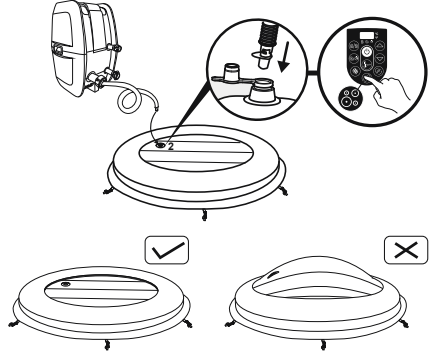

7

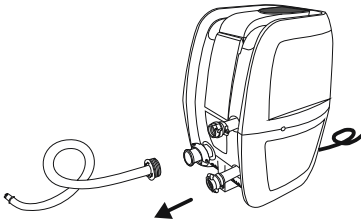

8

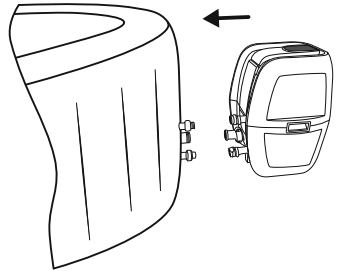

9

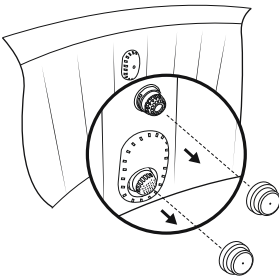

10

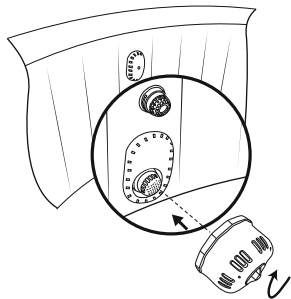



**GFCI TEST**

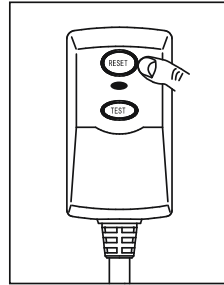
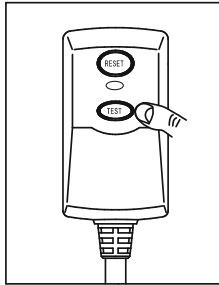
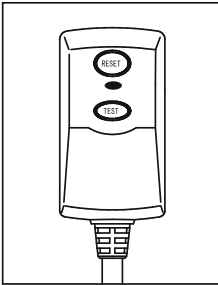

When inflating, you will notice that air will be expelled from the area where the air hose connects to the pump, this is normal for technique requirements.

**Important:** Don't cover the holes on the base of the inflation hose. This operation will over inflate the liner and damage the structure.

Do not use an air compressor to inflate the pool.

Do not drag the pool on rough ground as this may cause damage to the pool liner.

Inflation time for reference only.

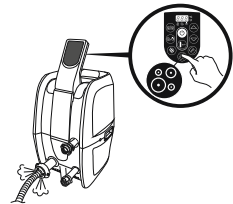

# USING THE SPA

Hyperthermia occurs when the internal temperature of the body reaches a level several degrees above the normal body temperature of 98.6°F(37°C). The symptoms of hyperthermia include an increase in the internal temperature of the body, dizziness, lethargy, drowsiness, and fainting. The effects of hyperthermia include failure to perceive heat, failure to recognize the need to exit spa or hot tub, unawareness of impending hazard, fetal damage in pregnant women, physical inability to exit the spa or hot tub, and unconsciousness resulting in the danger of drowning.

**WARNING** – The use of alcohol, drugs, or medication can greatly increase the risk of fatal hyperthermia.

**WARNING: WATER TEMPERATURE IN EXCESS OF 100°F(38°C) CAN BE INJURIOUS TO YOUR HEALTH.**

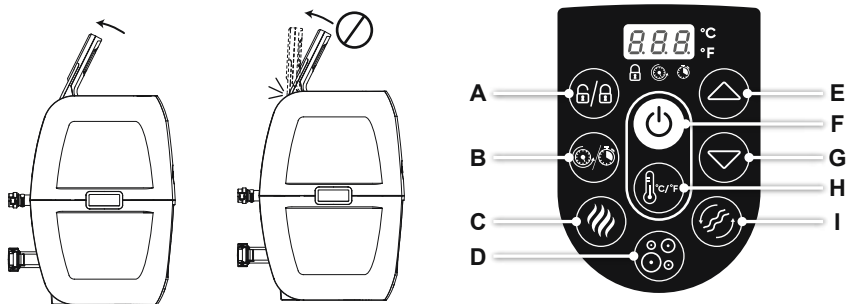

**A. LOCK/UNLOCK BUTTON:** The pump has a 5-minute auto-lock, this light will turn on. To lock or unlock the pump, place a finger over the lock/unlock button for 3 seconds.



**B. POWER-SAVING TIMER BUTTON:** Designed to help avoid wasting power by setting the time and duration of the heating cycle for the spa. This way, you can enjoy your spa at the time you desire, without needing to leave the heater on at all times.

**STEP 1: Set the heating duration**

1. Press the button until the LED starts to flash.
2. Press the or button to adjust the heating duration (From 1-999 hours).
3. Press the button again to confirm the heating duration.

**STEP 2: Set the number of hours FROM NOW when the heater will activate**

1. After setting the heating duration, the LED starts to flash.
2. Press the or button to adjust the hours until time of activation (From 0-999 hours).
3. Press button again or simply touch nothing for 10 seconds to confirm the setting. The LED will light steadily, and the countdown to heater activation will begin.

To modify the timer settings: Press the button and use the or button to adjust. Cancel the setting: Press the button for 2 seconds.

**NOTE:** After setting, the screen flashes the current temperature and time alternately.

**NOTE:** Timer adjustment (amount of time with the heater ON) may be set from 1 to 999 hours; Reservation time adjustment (the number of hours FROM NOW when the heater will begin to function) may be set from 0 to 999 hours. If the timer is set at 0 hour, the heating system will activate immediately.

Note that the timer is one time per use - the user sets the duration of the heating cycle, and how many hours from now the heating cycle begins. The timer does NOT repeat until reset.



**C. HEAT BUTTON:** Use this button to activate the heating system. When the light above the heat button is red, the heating system is activated. When the light is green, the water is at the set temperature and the heating system is at rest.

**NOTE:** If the heating system is activated the filtration system will automatically start.

**NOTE:** After turning off the heating system the filtration system will continue to operate.

**NOTE:** If the spa heater is on when the water temperature is below 42.8°F(6°C), the heating system will warm the water until 50°F(10°C) automatically.



**D. MASSAGE SYSTEM BUTTON:** Use this button to activate the massage system, which has a 30-minute auto-shutoff feature. The light above the Massage System Button displays red when activated.

**IMPORTANT:** Do not run the Massage system when the cover is attached. Air can accumulate inside the spa and cause irreparable damage to the cover and bodily harm.

**NOTE:** Heat and massage system work together to create a warm massage experience.



**E/G. TEMPERATURE ADJUSTMENT BUTTONS:** Pressing the Temperature Increase or Decrease buttons will cause the LED to flash. When it is flashing you can adjust to the desired temperature setting. If you hold these buttons down the values will rapidly increase or decrease. The new and desired temperature setting will remain on the LED display for 3 seconds to confirm the new value.



**NOTE:** The default temperature is 95°F(35°C).

**NOTE:** Temperature adjustment ranges from 68°F(20°C) to 104°F(40°C).



**F. ON/OFF BUTTON:** Press this button for 2 seconds to active the control panel buttons and the light turns to green. Press this button for 2 seconds to turn off all currently activated functions.



**H. CELSIUS/FAHRENHEIT TOGGLE:** The temperature can be displayed in either Fahrenheit or Celsius.



**I. WATER FILTER BUTTON:** This button turns the filter pump on and off. The light above the Water Filter Button displays red when activated.



**POWER-SAVING TIMER LED:**

This flashing LED means you are setting the heating duration. The light will be on when the heating function starts to work.



This flashing LED means you are setting the number of hours FROM NOW when the heater will activate. When the light is on, the Power-Saving Timer function is set.

**NOTE:** The WATER HEATER rate may change in the conditions below:

- When the outdoor temperature is below 59°F(15°C).
- If the cover is not in position when the heating function is activated.

**NOTE:** To display the current water temperature, run the filter system for at least a minute.

The water temperature as tested by an external thermometer may vary from the temperature as displayed on the spa panel by as much as approximately 35.6°F(2°C).

## WINTER USE INSTRUCTIONS



- You can keep the spa on during winter when the temperature is lower than 42.8°F(6°C). The Freeze Shield™ system automatically keeps the water temperature between 42.8°F(6°C) and 50°F(10°C), and it will prevent the water from freezing. **Important:** If the water temperature is below 42.8°F(6°C), the spa heater must always be on. In this mode, the Freeze Shield™ system can keep the internal temperature between 42.8°F(6°C) and 50°F(10°C) to prevent damage, such as water freezing in the pipes or the circulation system. **Important:** If the Freeze Shield™ system isn't working, alarms will pop up on the spa. Be sure to check the status of your spa if the outdoor temperature is below 42.8°F(6°C). In case of a long-term absence from home when there is a risk of temperatures falling below 42.8°F(6°C), we strongly suggest disassembling the spa and storing it following the storage procedure.
- Any damage as a result of using the spa in these conditions is the responsibility of the customer. Do not use the spa when the ambient temperature reaches 14°F(-10°C).

## IMPORTANT

To reach 104°F(40°C), the heating duration required is based on the starting water temperature and ambient temperature, the data below is purely for reference. To display the current water temperature, run the filter system for at least a minute.

Ambient Temperature	Water Temperature	Set Temperature	Heating Duration
50°F(10°C)	50°F(10°C)	104°F(40°C)	32 h
59°F(15°C)	59°F(15°C)	104°F(40°C)	26 h
68°F(20°C)	68°F(20°C)	104°F(40°C)	20 h
77°F(25°C)	77°F(25°C)	104°F(40°C)	14 h
86°F(30°C)	86°F(30°C)	104°F(40°C)	9 h

- Be sure to cover the spa with the spa cover whenever the heating function is activated. Leaving the spa uncovered will increase the heating duration required.
- When the spa is assembled with water, do not switch off the spa heater if the temperature is lower than 42.8°F(6°C).

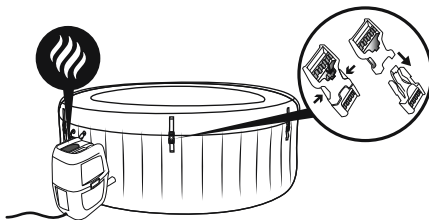

Power Rate	Massage Tube Blower	Heat Element	Water Pump
110-120V AC, 60Hz, Single Phase 12A at 20°C	6.5A	11.3A at 20°C	0.7A

# MAINTENANCE

**CAUTION:** You must ensure the pump is unplugged before beginning spa maintenance to avoid risk of injury or death.

**Adding Air:** Your spa will require additional air to be added from time to time. Changes in temperature from day to night will change the pressure in the spa and may cause a certain amount of deflation. Please follow the assembly instructions and inflate to the accurate pressure needed.

When you need to use the pump for inflation, please block the hoses to prevent water from escaping, then disconnect the pump, screw on the cap (#10) to avoid water coming out from the air pipe.

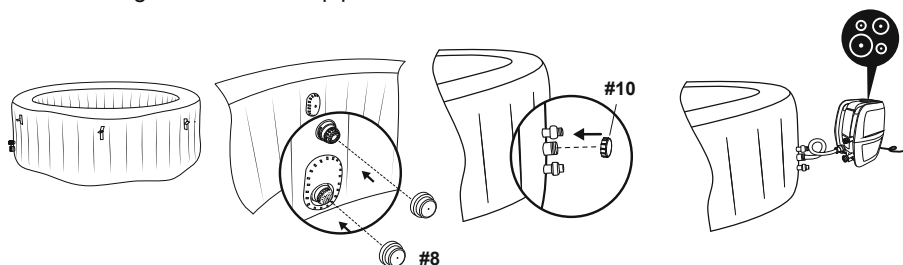

## Cover Maintenance

The cover shall be cleaned inside and out periodically using a suitable solution that includes adequate disinfection (e.g. 10 mg/l of Free Chlorine).

## Filter Cartridge Maintenance

To ensure your spa water stays clean, check and clean your filter cartridges every day follow the steps below.

**NOTE:** We recommend changing your filter cartridges every week or, if the filter cartridges remain soiled and discolored, they should be replaced.

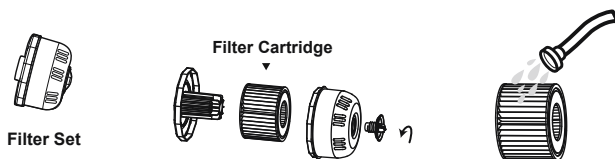

## Water Maintenance

Many pollutants in the water settle on surfaces below the water line. These pollutants can cause bacterial, algal or fungal growth. It is recommended that spas are cleaned as regularly as necessary. After a time, tenacious stains or biofilms may develop on the accessible surfaces below the water line or high concentrations of salts or unwanted reaction by-products may also occur. Depending on hygienic condition, cleanliness, visibility, odour, debris and stains, it is recommended to change the water completely and clean/disinfect the spa. When emptying the spa, the regulations and the instructions for draining the water shall be observed.

Keeping your spa water clean and chemically balanced is necessary. Simply cleaning the filter cartridge is not enough for proper maintenance, we recommend you use pool chemicals to maintain water chemistry and chlorine or bromine tablets (do not use granules) with the chemical dispenser.



Water quality will be directly related to frequency of use, number of users and overall maintenance of the spa. The water should be changed every 3 days if there is no chemical treatment being performed with the water. It is highly recommended to use tap water for spa filling to minimize the influence of unwanted content, such as minerals. Barefoot areas and relaxing areas shall be cleaned as well. No cleaning water may flow into the spa or spa water cycle. The dirt and cleaning agents shall be rinsed carefully to drain in the spa surround. **Note:** We recommend you take a shower before using your SaluSpa, as cosmetic products, lotions, and other residues on the skin can quickly degrade water quality. To use the chemical dispenser, please follow the below instruction.

**Using chemical tablets (not included):**

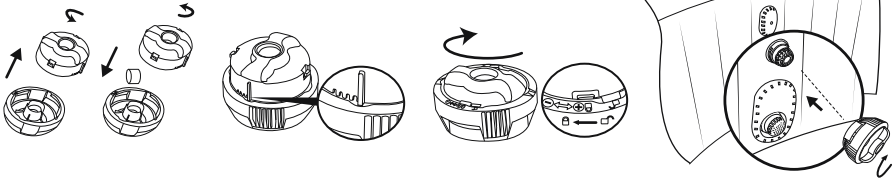

**Important:** Don't use granulate tablets or throw the tablet directly in the water. The chemicals can deposit on the bottom, damage the material and discolor the PVC.

**Using chemical liquid (not included):**

**Important:** Add chemical liquid in small doses and in the center of the pool to avoid direct contact between the chemicals and the PVC surface. Direct contact can damage the material and discolor the surface.

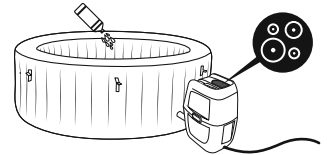

**NOTE:** Remove the chemical dispenser from spa when the spa is in use.

**IMPORTANT:** After performing chemical maintenance and before using the spa, use a test kit (not included) to test the water chemistry. We recommend maintaining your water according to the following table.

pH	Total Alkalinity	Free Chlorine
7.4-7.6	80-120ppm	2-4ppm

**NOTE:** Damage resulting from chemical imbalance is not covered by the warranty. Pool chemicals are potentially toxic and should be handled with care. There are serious health risks from chemical vapors and the incorrect labeling and storage of chemical containers. Please consult your local pool supply retailer for more information about chemical maintenance. Pay close attention to the chemical manufacturer's instructions. spa damage resulting from misuse of chemicals and mismanagement of spa water is not covered by the warranty.

**Important:** Over usage of chemicals can discolor the printing and all points of the spa material. It can also damage the structure of the spa liner.

# DISASSEMBLY AND STORAGE

## DRAINING THE SPA

1.

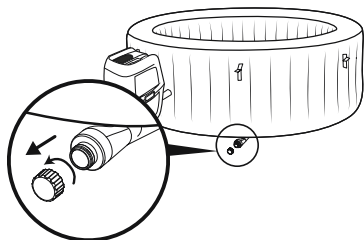

2.

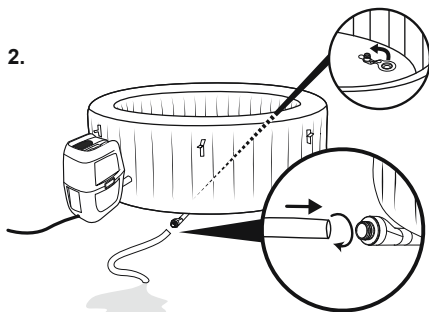

3. **NOTE:** Dry the spa pool.



4.

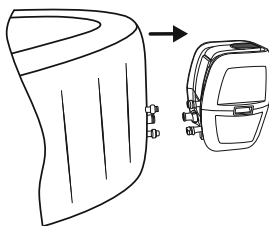

5.

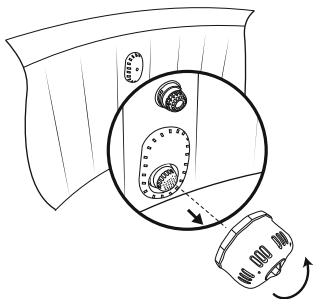

Make sure the spa and pump are completely dry. This is essential to extend the life of the spa. We recommend using the pump to blow dry the spa, pump and pipes. Remove the filter sets and discard the used filter cartridges. Re-attach the two stopper caps onto the spa's inlet and outlet valves. It is recommended you store the spa in its original package in a warm [above 59°F(15°C)] and dry place.

## CLEANING THE SPA

Detergent residues and dissolved solids from bathing suits and chemicals may build up on the spa walls. Use soap and water to clean the walls and rinse thoroughly.

NOTE: DO NOT use hard brushes or abrasive cleaners.

## DEFLATION

Your spa is equipped with a deflation function to remove all the air from inside the chamber to make it easier to pack and store.

Screw valve 

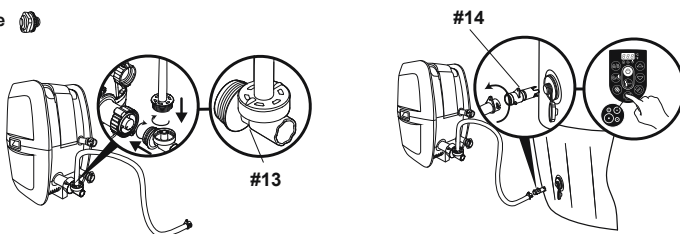

## REPAIR

### For PVC part.

If the spa is torn or punctured, use the provided underwater adhesive repair patch.

1. Clean area to be repaired.
2. Carefully peel patch.
3. Press patch over area to be repaired.
4. Wait 30 seconds before inflation.



### For Tritech PVC material.

If the spa is torn or punctured, use the provided PVC repair patch and glue (not included) following these steps:







1. Clean and dry area to be repaired.
2. Cut the provided PVC patch to appropriate size.
3. Use glue (not included) to coat the one side of the newly cut patch. Make sure the glue is evenly distributed.
4. Wait for 30 seconds and then place the cut patch with glue over the damaged area.
5. Smooth out any bubbles of air that may be trapped underneath, and press firmly for two minutes.
6. The product is once again ready for use. Repeat this process should further leaks occur.
7. Wait 30 minutes before inflation.

# TROUBLESHOOTING

Bestway strives to provide the most trouble-free spas on the market. If you experience any problems whatsoever, do not hesitate to contact Bestway or your authorized dealer. Here are some helpful tips to help you to diagnose and rectify some common sources of trouble.

Problems	Probable Causes	Solutions
Pump does not operate	<ul style="list-style-type: none"> <li>- Power failure</li> <li>- GFCI broken</li> </ul>	<ul style="list-style-type: none"> <li>- Check power source</li> <li>- For assistance, please visit the support section on our website, <a href="http://www.bestwaycorp.com">www.bestwaycorp.com</a>.</li> </ul>
Pump does not heat properly	<ul style="list-style-type: none"> <li>- Temperature set too low</li> <li>- Dirty Filter Cartridge</li> <li>- The thermal cut-out cut off</li> <li>- Spa is not covered</li> <li>- Heating element failed</li> </ul>	<ul style="list-style-type: none"> <li>- Set to a higher temperature refer to section pump operation</li> <li>- Clean/replace the filter cartridge refer to section filter cartridge cleaning and replacement</li> <li>- Unplug the pump, and put the plug in a dry, cool place. Only restart the pump when the water temperature reaches 95°F(35°C) or lower</li> <li>- Attach the cover.</li> <li>- For assistance, please visit the support section on our website, <a href="http://www.bestwaycorp.com">www.bestwaycorp.com</a>.</li> </ul>
Massage System does not work	<ul style="list-style-type: none"> <li>- Air Pump is overheating</li> <li>- The massage system stops automatically</li> <li>- Air pump is broken</li> </ul>	<ul style="list-style-type: none"> <li>- Unplug the pump and wait two hours until the pump has cooled. Insert the plug and press the massage system button</li> <li>- Press the massage system button to reactivate</li> <li>- For assistance, please visit the support section on our website, <a href="http://www.bestwaycorp.com">www.bestwaycorp.com</a>.</li> </ul>
Pump adapters are not level with the spa adapters	<ul style="list-style-type: none"> <li>- One characteristic of PVC is that it changes shape, which is normal</li> </ul>	<ul style="list-style-type: none"> <li>- Elevate the pump with wood or another type of insulated material to bring the pump's adapters level with the spa's adapters</li> </ul>
Spa pool leakage	<ul style="list-style-type: none"> <li>- Spa is torn or punctured</li> <li>- Air valve is loose</li> </ul>	<ul style="list-style-type: none"> <li>- Use provided repair patch</li> <li>- Using soapy water, cover the air-valve to check if air is leaking, if so, use the provided wrench to fasten the air-valve following these steps:               <ol style="list-style-type: none"> <li>1. Deflate the spa.</li> <li>2. With one hand, hold the backside of the air valve from the inner side of the spa wall and turn the wrench clockwise.</li> </ol> </li> </ul>
Water is not clean	<ul style="list-style-type: none"> <li>- Insufficient filtering time</li> <li>- Dirty Filter Cartridge</li> <li>- Improper water maintenance</li> </ul>	<ul style="list-style-type: none"> <li>- Increase filtration time</li> <li>- Clean/replace the Filter Cartridge (refer to Filter Cartridge Cleaning and Replacement section)</li> <li>- Refer to the chemical manufacturer's instructions</li> </ul>
Control panel not working	<p>The control panel has an auto-lock, which is activated after 5 minutes of inactivity. The LED display has one icon: . If the lock icon is highlighted, the control panel is locked.</p> <ul style="list-style-type: none"> <li>- Control panel is not activated.</li> </ul>	<ul style="list-style-type: none"> <li>- To unlock the control panel, press the  button for 3 seconds. If the control panel will not unlock, restart the pump – unplug and plug in the pump.</li> <li>- Press the on/off button for 2 seconds. If the problem persists, for assistance, please visit the support section on our website, <a href="http://www.bestwaycorp.com">www.bestwaycorp.com</a>.</li> </ul>
GFCI test failed	<p>There is a defect in your spa</p>	<p>For assistance, please visit the support section on our website, <a href="http://www.bestwaycorp.com">www.bestwaycorp.com</a>.</p>
What kind of chemicals should be used for water maintenance?	<p>Please consult your local chemical supplier for information about chemical maintenance. Pay close attention to the chemical manufacturer's instructions.</p>	
Water leaks from the adapters between the pump and spa	<ul style="list-style-type: none"> <li>- Seals are missing inside the pump adapters</li> <li>- Seals are not in correct position</li> <li>- Seals are damaged</li> <li>- Adapters are not tightened correctly</li> </ul>	<ul style="list-style-type: none"> <li>- Insert the stopper caps on the spa ports to prevent the water from escaping and disconnect the pump. Check if the seals are in place.</li> <li>- If the seals are not in the correct position, open the gears, and place the seals in correct position.</li> <li>- If the seals are damaged, they must be replaced. For assistance, please visit the support section on our website, <a href="http://www.bestwaycorp.com">www.bestwaycorp.com</a>.</li> <li>- If the seals are in correct position, the adapters are not tightened correctly. Connect the pump to the spa, hand-tighten the adapters, and remove the stopper caps from the spa ports. If there is leakage, tighten the adapter until there is no leakage.</li> </ul>

# ERROR CODES

CAUSES	REASONS	SOLUTIONS
<p>The water flow sensors work without pressing the filter or heat button.</p> 	<ol style="list-style-type: none"> <li>The water flow sensor flags didn't fall back into the correct position.</li> <li>The water flow sensors are broken.</li> </ol>	<ol style="list-style-type: none"> <li>Unplug the plug, strike the side of the pump but not violently, and plug it back in.</li> <li>For assistance, please visit the support section on our website, <a href="http://www.bestwaycorp.com">www.bestwaycorp.com</a>.</li> </ol>
<p>After starting or during the functions of filtering or/and heating, the water flow sensors do not detect water flow.</p> 	<ol style="list-style-type: none"> <li>You forgot to remove the 2 stopper caps from inside the pool.</li> <li>Filter cartridges are dirty.</li> <li>Activate the filter or heat system and put your hand in front of the outlet pipe inside the pool to check if you can feel water flowing out.             <ol style="list-style-type: none"> <li>If no water flows out the water pump is broken.</li> </ol> </li> <li>Water flows out but the alarm  appears, then the water flow sensors are broken.</li> <li>Filter blockage</li> <li>Bent pipes or poor water flow through the plastic pipes of the liner</li> <li>Debris screens are blocked: debris screens can become blocked by hard water due to calcium build-up.</li> <li>Perished washers The washers within the spa couplings may have become perished or worn.</li> </ol>	<ol style="list-style-type: none"> <li>Remove the 2 stopper caps before heating, refer to Assembly section in the User's Manual.</li> <li>Remove the filter set from inside the pool and push the filter or heat button. If no alarm appears, clean or change the filter cartridges install the filter set inside the pool.</li> <li>For assistance, please visit the support section on our website, <a href="http://www.bestwaycorp.com">www.bestwaycorp.com</a>.</li> <li>Clean the filter and check for damage. Replace or re-install as necessary. For assistance, please visit the support section on our website, <a href="http://www.bestwaycorp.com">www.bestwaycorp.com</a>.</li> <li>Please check through the spa connection to see if the pipes are bending. For assistance, please visit the support section on our website, <a href="http://www.bestwaycorp.com">www.bestwaycorp.com</a>.</li> <li>Empty the spa and place a garden hose inside the pipes to wash the debris. To be sure all debris is removed, perform the operation from the outside and inside of the spa. Use a toothbrush to remove any stubborn debris. For assistance, please visit the support section on our website, <a href="http://www.bestwaycorp.com">www.bestwaycorp.com</a>.</li> <li>Check the washers inside the coupling for damage. Unscrew the couplings and remove the washer for further inspection. For assistance, please visit the support section on our website, <a href="http://www.bestwaycorp.com">www.bestwaycorp.com</a>.</li> </ol>
<p>The pump's thermometer reads the water temperature below 40°F(4°C).</p> 	<ol style="list-style-type: none"> <li>The water temperature is lower than 40°F(4°C).</li> <li>If the water temperature is higher than 44.6°F(7°C), the pump's thermometer is broken.</li> </ol>	<ol style="list-style-type: none"> <li>The spa is not designed to operate with water temperatures lower than 40°F(4°C). Unplug the pump and only re-start the pump when the water temperature reaches 43°F(6°C).</li> <li>For assistance, please visit the support section on our website, <a href="http://www.bestwaycorp.com">www.bestwaycorp.com</a>.</li> </ol>
<p>The pump's thermometer reads the water temperature over 119°F(48°C).</p> 	<ol style="list-style-type: none"> <li>The water temperature is over 119°F(48°C).</li> <li>The ambient temperature is higher than 104°F(40°C) or the spa is exposed to direct sunlight for an extended period of time.</li> <li>If the water temperature is lower than 113°F(45°C), the pump's thermometer is broken.</li> </ol>	<ol style="list-style-type: none"> <li>The spa is not designed to operate with water temperatures greater than 104°F(40°C). Unplug the pump and only re-start the pump when the water temperature reaches 100°F(38°C) or lower.</li> <li>Disconnect the plug, detach the pump and drain the spa. After 15 minutes, reattach the pump, reconnect the plug and restart the heating function. If the alarm appears again, consider moving the spa to another location without direct sunlight.</li> <li>For assistance, please visit the support section on our website, <a href="http://www.bestwaycorp.com">www.bestwaycorp.com</a>.</li> </ol>
<p>The pump's thermometer connections have issues.</p> 	<ol style="list-style-type: none"> <li>The pump's thermometer connectors don't work properly.</li> <li>The pump's thermometer is broken.</li> </ol>	<p>For assistance, please visit the support section on our website, <a href="http://www.bestwaycorp.com">www.bestwaycorp.com</a>.</p>
<p>The thermal cut-out cut off.</p> 	<ol style="list-style-type: none"> <li>The ambient temperature is over 122°F(50°C) or the pump is directly under the sunshine.</li> <li>The thermal cut-out is broken.</li> </ol>	<ol style="list-style-type: none"> <li>Unplug the pump, and put the pump in a dry, cool place. Only re-start the pump when the water temperature reaches 93.2°F(34°C) or lower.</li> <li>For assistance, please visit the support section on our website, <a href="http://www.bestwaycorp.com">www.bestwaycorp.com</a>.</li> </ol>

# Supplier's Declaration of Conformity

## Under FCC Part 15 SDoC procedure

Product Description : SPA

Model Number : S100105

Trade Name : Bestway

Responsible Party in USA : Bestway (USA) Inc.  
3435 S. McQueen Road, Chandler, AZ 85286,  
United States of America

Testing Laboratory : Intertek Testing Services Shanghai  
Building No.86, 1198 Qinzhou Road (North),Caohejing  
Development Zone, Shanghai 200233, China

Addendum to the Test Report : 200101172SHA-001

### FCC Compliance Statement

This device complies with part 15 of the FCC Rules. Operation is subject to the following two conditions: (1) This device may not cause harmful interference, and (2) this device must accept any interference received, including interference that may cause undesired operation.

For and on behalf  
of Responsible Party



Mi Huang

info@bestwaycorp.us





For support please visit us at:  
[bestwaycorp.com/support](http://bestwaycorp.com/support)

**©2021 Bestway Inflatables & Material Corp.**

All rights reserved/Tous droits réservés/Todos los derechos reservados/Alle Rechte vorbehalten/Tutti i diritti riservati

Trademarks used in some countries under license from/

Marques utilisées dans certains pays sous la licence de/

Marcas comerciales utilizadas en algunos países bajo la licencia de/

Die Warenzeichen werden in einigen Ländern verwendet unter Lizenz der/

Marchi utilizzati in alcuni paesi concessi in licenza a

**Bestway Inflatables & Material Corp., Shanghai, China**

Manufactured, distributed and represented in the European Union by/

Fabriqué, distribués et représentés dans l'Union Européenne par/Fabricado, distribuido y representado en la Unión Europea por/

Hergestellt, vertrieben und in der Europäischen Union vertreten von/Prodotto, distribuito e rappresentato nell'Unione Europea da

**Bestway (Europe) S.r.l., Via Resistenza, 5, 20098 San Giuliano Milanese (Milano), Italy**

Distributed in Latin America by/Distribué en Amérique latine par/Distribuido en Latinoamérica por/Distribuido na América Latina por

**Bestway Central & South America Ltda, Salar Ascotan 1282, Parque Enea, Pudahuel, Santiago, Chile**

Distributed in Australia & New Zealand by **Bestway Australia Pty Ltd, Unit 2/98-104 Carnarvon St Silverwater, NSW 2128, Australia**

Tel: Australia: (+61) 29 0371 388; New Zealand: 0800 142 101

Distributed in United Kingdom by **Bestway Corp UK Ltd, 8 Wentworth Road, Heathfield Industrial Estate, Newton Abbot, Devon, TQ12 6TL**

Exported by/Exporté par/Exportado por/Exportiert von/Esportato da

**Bestway (Hong Kong) International Ltd./Bestway Enterprise Company Limited**

**Suite 713, 7/Floor, East Wing, Tsim Sha Tsui Centre, 66 Mody Road, Kowloon, Hong Kong**

Tel: +86 21 69135588 (For U.S. and Canada)

[www.bestwaycorp.com](http://www.bestwaycorp.com)